

**OSRAM**  
 Opto Semiconductors

OSRAM Opto Semiconductors, Inc.

## SFH 7710

Pjesa e Numrit:

SFH 7710

Prodhuesi / Markë:

OSRAM Opto Semiconductors, Inc.

Përshkrim i produktit

SENSOR TILT DIGITAL 10MA SMD

datasheets:

 SFH 7710.pdf

Statusi i RoHS

 Pa plumb pa përputhshmëri me RoHS

Anije nga

Hong Kong

Mënyra e dërgesës

DHL/Fedex/TNT/UPS/EMS

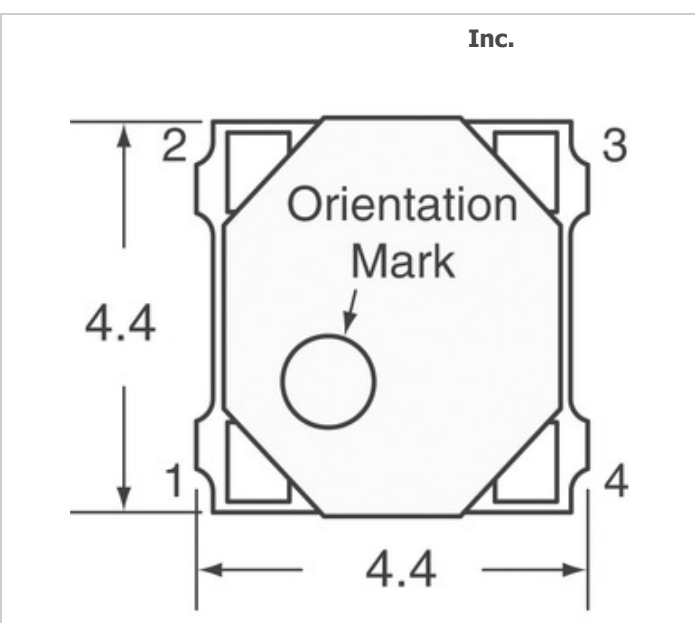
[KËRKESA PËR KUOTIM](#)

Imazhi mund të jetë përfaqësues. Shihni specifikimet për detajet e produktit.











### Specifikimet e SFH 7710

PJESA E NUMRIT	SFH 7710
PRODHUES	OSRAM Opto Semiconductors, Inc.
PËRSHKRIM	SENSOR TILT DIGITAL 10MA SMD
STATUSI I LIRË I PLUMBIT / ROHS	Pa plumb pa përputhshmëri me RoHS
FLETA E TË DHËNAVE	 SFH 7710.pdf
FURNIZIMI ME TENSION	2.3 V ~ 3.6 V
SERI	-
PAKETIM	Tape & Reel (TR)
PAKETA / RASTI	4-SMD
LLOJI I DALJES	Digital, Open Drain
EMRA TË TJERË	475-1269-2 Q3437777 Q65110A4407 SFH 7710-Z
TEMPERATURA E PUNËS	-20°C ~ 65°C
ANGLE OPERATIVE	-
LLOJI I MONTIMIT	Surface Mount
NIVELI I NDJESHMËRISË SË LAGËSHTISË (MSL)	4 (72 Hours)
STATUSI I LIRË I PLUMBIT / ROHS	Lead free / RoHS Compliant
PRODHIMI AKTUAL -	10mA

### Lidhje të ngjashme

OSRAM Opto Semiconductors, Inc. SFH 7710	Distributori SFH 7710	Furnizuesi SFH 7710
Amimi SFH 7710	Fotografitë SFH 7710	Imazhi SFH 7710
Tabela e të dhënave PDF SFH 7710	Shkarkoni të Dhënat SFH 7710	Fleta e të dhënave SFH 7710
Aksioneve SFH 7710	Bleni SFH 7710	Bleni OSRAM Opto Semiconductors, Inc. SFH 7710
OSRAM Opto Semiconductors, Inc. SFH 7710	Furnizuesi OSRAM Opto Semiconductors, Inc.	Distributori OSRAM Opto Semiconductors, Inc.
OSRAM Opto Semiconductors, Inc. SFH 7710	OSRAM Opto Semiconductors Inc. SFH 7710	

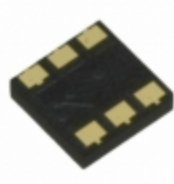
### Produkte të ngjashme

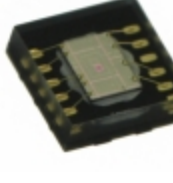
 <p><b>SFH 7225-Z</b>          Prodhuesit: OSRAM Opto Semiconductors, Inc.          Përshkrim: LED YELLOW CLEAR SMD          Në magazinë: Out stock</p> <p><a href="#">RFQ</a></p>	 <p><b>SFH 7251</b>          Prodhuesit: OSRAM Opto Semiconductors, Inc.          Përshkrim: EMITTER IR MULTI TOPLED          Në magazinë: Out stock</p> <p><a href="#">RFQ</a></p>
 <p><b>SFH 757</b>          Prodhuesit: International Rectifier (Infineon Technologies)          Përshkrim: TRANSMITTER DIODE FIBER OPTIC          Në magazinë: Out stock</p> <p><a href="#">RFQ</a></p>	 <p><b>SFH 7250</b>          Prodhuesit: OSRAM Opto Semiconductors, Inc.          Përshkrim: EMITTER IR 850NM          Në magazinë: Out stock</p> <p><a href="#">RFQ</a></p>
 <p><b>SFH 7771</b>          Prodhuesit: OSRAM Opto Semiconductors, Inc.          Përshkrim: CHIP ON BOARD          Në magazinë: Out stock</p> <p><a href="#">RFQ</a></p>	 <p><b>SFH 7770 E6</b>          Prodhuesit: OSRAM Opto Semiconductors, Inc.          Përshkrim: ALS, PROXIMITY SENSOR (2-IN-1)          Në magazinë: Out stock</p> <p><a href="#">RFQ</a></p>
 <p><b>SFH 7252</b>          Prodhuesit: OSRAM Opto Semiconductors, Inc.          Përshkrim: MULTI TOPLED          Në magazinë: Out stock</p> <p><a href="#">RFQ</a></p>	 <p><b>SFH 7741-Z</b>          Prodhuesit: OSRAM Opto Semiconductors, Inc.          Përshkrim: PROXIMITY SENSOR 30MM          Në magazinë: Out stock</p> <p><a href="#">RFQ</a></p>
 <p><b>SFH 7740-Z</b>          Prodhuesit: OSRAM Opto Semiconductors, Inc.          Përshkrim: SENSOR OPTO REFLECTIVE 6SMD          Në magazinë: Out stock</p> <p><a href="#">RFQ</a></p>	 <p><b>SFH 757V</b>          Prodhuesit: International Rectifier (Infineon Technologies)          Përshkrim: TRANSMITTER DIODE FIBER OPTIC          Në magazinë: Out stock</p> <p><a href="#">RFQ</a></p>
 <p><b>SFH 7743-Z</b>          Prodhuesit: OSRAM Opto Semiconductors, Inc.          Përshkrim: PHOTODETECTOR SCHMITT SMD          Në magazinë: Out stock</p> <p><a href="#">RFQ</a></p>	 <p><b>SFH 7770</b>          Prodhuesit: OSRAM Opto Semiconductors, Inc.          Përshkrim: LIGHT SENSOR AMBIENT SMD          Në magazinë: Out stock</p> <p><a href="#">RFQ</a></p>

E drejta e autorit © 2020 Distributor i besueshëm i përbërësve elektronikë - Ocean-Components.com

E-mail: [Info@Ocean-Components.com](mailto:Info@Ocean-Components.com)

Adresa: Room 2102, Connaught Commercial Building, 185 Wan Chai Rd, Wan Chai, Hong Kong

