



Laird Technologies is the world-leader in the design and supply of customized performance-critical products for wireless and other advanced electronic applications. Laird Technologies partners with its customers to help find solutions for applications in various industries such as:

Network Equipment
Telecommunications
Data Communications
Automotive Electronics
Computers
Aerospace
Military
Medical Equipment
Consumer Electronics

Laird Technologies offers its customers unique product solutions, dedication to research and development and a seamless network of manufacturing and customer support facilities located all across the globe.

global solutions :
local support .

Contents

- Introduction** 3
- Omnidirectional Collinear Antennas** 4
 - S2403BPX 2.4 GHz 5 dBi Omni, S2406BFNM 2.4 GHz 8 dBi High gain collinear 4
 - S2403BP 2.4 GHz 3 dBi Outdoor Pole Mount Omni, S2403BH 2.4 GHz 3 dBi Ceiling Mount Omni 5
 - S4906WB Wide-Band VPOL 5 Ghz Omni, S24513BPX 2.4-2.5 & 5.15-5.875 GHz Dual band Omni 6
 - S4908BF Wide-Band VPOL 10 dBi 5 GHz Omni, S51513WBP 5.15-5.875 GHz Wide-Band Omni 7
 - S5158WBPX 5.150-5.875 GHz Wide-Band Omni 8
- Omnidirectional Panel Antennas** 9
 - SQ2403PG 2.4 GHz 3.5 dBi Patch, SQ2303P 2.3-2.5 GHz 3.5 dBi Ceiling Panel 9
 - SQ5153WP 5.150-5.875 GHz Wide-Band Ceiling Mount Squint 10
- Integrated Diversity Omnidirectional Panel Antennas** 11
 - S2402DS 2.4 GHz 2 dBi Integrated Omni, S4903WDS 4.90-5.87 GHz 3 dBi Integrated Spatial Diversity 11
 - S24493DS 2.4 GHz 3 dBi Spatial Diversity Directional 12
- Directional Panel Antennas** 13
 - S2307MP Direct Link™ 2300-2500 MHz, S2406P 2.4 GHz 6 dBi Panel 13
 - S2408P 2.5 GHz 8 dBi Panel, S2401240P 2.4 GHz 12 dBi Panel 14
 - S24015P 2.5 GHz 15 dBi High-Gain Panel, S51512MP Direct Link™ 5150-5350 MHz 15
 - S51514WP 5.15-5.875 GHz Wide-Band, S54717P 5.47-5.85 GHz Wide-Band Panel 16
 - S24497P 2.4 & 5.9 GHz Dual-Band Tri-Mode Panel 17
- Integrated Diversity Directional Panel Antennas** 18
 - S2406DSP 2.4 GHz Spatial Diversity Directional 18
- Directional Yagi Antennas** 19
 - PC2415N 2.4 GHz 13.9 dBi Yagi, S2408MD 2.5 GHz Directional Ceiling Mount 8 dBi Array 19
- Sector Directional Panel Antennas** 20
 - SR2405135D 2.4 GHz 5 dBi PCS/DCS Wide-Angle Panel, S240790P 2.4 GHz 7 dBi Wide-Angle Panel 20
 - SR24011120D 2.4 GHz 11 dBi Wide-Angle Directional Sector, SR5120WD 5.5-5.35 GHz 120° Sector 21
 - S4901790PNF ETSI CS1 VPOL 5 GHz Sector, SR249120D 2.4 & 5.0 GHz Dual-Band 120° Sector 22
- Dual Directional Panel Antennas** 23
 - SQ2405DD 2.4 GHz 4 dBi Bi-Directional Ceiling Mount 23
- Variable Directivity Special Purpose Antennas** 24
 - SL2402P 2.4 GHz Omni-Directional Ceiling Mount, SL24513P 2.4-2.5 & 5.15-5.35 Ghz, 3 dBi Dual band Omni-Directional Squint 24
 - TRA24003 2.4 GHz 3 dBi Mobile, Io5250 5 GHz 5 dBi Omni In-Building 25
 - WXE2400 2.4 GHz 3 dBi Mobile Dipole, WTS2450 2.4-2.5 & 4.9-6.0 GHz 5 dBi In-buliding 26
 - IF2450-SF00 2.4 GHz 3 dBi In-Building Omni 27
- Accessories** 28

Locations

- Laird Technologies WLAN Antenna Locations** 29

Laird Technologies WLAN Antennas

Welcome to the Laird Technologies WLAN antenna catalog. We hope you will find it a ready reference guide and a handy tool for filling your WLAN 802.11 antenna requirements. The catalog includes specifications and application notes for a multitude of antenna variables that span the industry's most productive, broadly based product offering for WLAN access point system applications.

Please note that in several instances we have provided you with a core part number and specifications for an antenna and several alternatives differentiated by the part number suffix. In these cases we are identifying part we have built up over the years mainly as a consequence of our long standing relationships with the industry's most prominent WLAN radio OEMs'. If however you require an alternative to the options we have identified please do not hesitate to contact us.

The catalog also points out when a mounting hardware package is included with the antenna and provides some guidance relative to the applications which are most common to a particular antenna. Many of the antennas in this catalog have been presented to you more recently as Cushcraft antennas, some as Centurion antennas and still others as Antenex antennas. They are now proud members of the Laird Technologies family of products.

We hope you enjoy browsing through our new WLAN antenna catalog. We will be adding to the catalog in order to provide a more comprehensive reference guide for your use. We wanted to provide you with a first glance at some of what will be the expanded set of WLAN antenna products that will now fly under the Laird Technologies banner. Many of these antennas represent the standard by which the rest of the WLAN antenna industry is measured. I am sure part of the fun for you, will be the number of times you see an antenna that you have actually seen in deployment in an auditorium or at an airport, in a mall, office park or industrial center or first discovered as part of a WLAN system package that you were deploying. We also want to take this opportunity to thank you for your business and for your continuing interest in our products and progress. Please feel free to contact us if you have any questions or comments.



2.4 GHz 5.2 dBi Omni Antenna

This 2.4 GHz indoor/outdoor omnidirectional antenna includes all of the mounting hardware for inverted ceiling mount, inverted I-beam mount or standard mast mounting.

Specifications:	Part Number S2403BPX
Frequency Range (GHz)	2.4-2.5
Gain (dBi)	5.2 (nominal)
VSWR	<1.5:1
Polarization	Linear vertical
Azimuth (3dB beamwidth)	Omnidirectional
Elevation (3dB beamwidth)	32°
Mounting Style	Beam / Mast, Ceiling
Power (Watts)	50
Dimensions (mm)	11.5" x 1" (292 x 25)

Antennas in this series

S2403BPX12NF	Antenna with 12" pigtail and type N female
S2403BPX36RTN	Antenna with 36" pigtail and reverse TNC male
S2403BPX48RBN	Antenna with 48" pigtail and reverse BNC male
S2403BPX36RSM	Antenna with 36" pigtail and reverse SMA male

Additional configurations also available

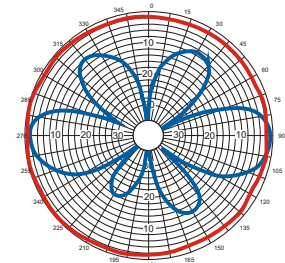

2.4 GHz ■ H-Plane
■ E-Plane

2.4 GHz 8 dBi High Gain Omni Antenna

This high gain collinear outdoor omnidirectional antenna is designed to be directly mounted to radio chassis or NEMA boxes that have mating connectors.

Specifications:	Part Number S2406BFNM
Frequency Range (GHz)	2.4-2.5
Gain (dBi)	8 (nominal)
VSWR	<1.5:1
Polarization	Linear vertical
Azimuth (3dB beamwidth)	Omnidirectional
Elevation (3dB beamwidth)	14°
Mounting Style	Pole / Mast, direct mount
Power (Watts)	50
Dimensions (mm)	20.24" x .90" (514 x 23)

Antennas in this series

S2406BFNM	Antenna with type N male
-----------	--------------------------

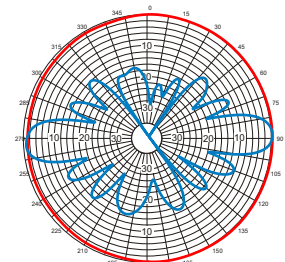

2.45 GHz ■ H-Plane
■ E-Plane

2.4 GHz 5.2 dBi Outdoor Pole Mount Omni Antenna

The original and still the most widely deployed outdoor omnidirectional antenna in the 2.4 GHz band.

Specifications:	Part Number S2403BP
Frequency Range (GHz)	2.4-2.5
Gain (dBi)	5.2 (nominal)
VSWR	<1.5:1
Polarization	Linear vertical
Azimuth (3dB beamwidth)	Omnidirectional
Elevation (3dB beamwidth)	38°
Mounting Style	Pole / Mast
Power (Watts)	50
Dimensions (mm)	11.5" x 1" (292 x 25)

Antennas in this series

S2403BP12NF	Antenna with 12" pigtail and type N female
S2403BP36RTN	Antenna with 36" pigtail and reverse TNC male
S2403BP48RBN	Antenna with 48" pigtail and reverse BNC male
S2403BP36RSM	Antenna with 36" pigtail and reverse SMA male

Additional configurations also available

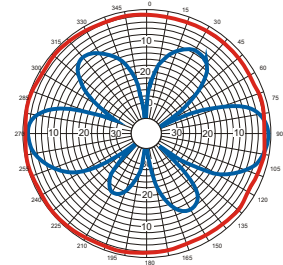

2.4 GHz ■ H-Plane ■ E-Plane

2.4 GHz 5.2 dBi Ceiling Mount Omni Antenna

The original and still the most widely deployed indoor omnidirectional collinear antenna in the 2.4 GHz band.

Specifications:	Part Number S2403BH
Frequency Range (GHz)	2.4-2.5
Gain (dBi)	5.2 (nominal)
VSWR	<1.5:1
Polarization	Linear vertical
Azimuth (3dB beamwidth)	Omnidirectional
Elevation (3dB beamwidth)	38°
Mounting Style	Ceiling
Power (Watts)	20
Dimensions (mm)	11.5" x 1" (292 x 25)

Antennas in this series

S2403BH12NF	Antenna with 12" pigtail and type N female
S2403BH36RTN	Antenna with 36" pigtail and reverse TNC male
S2403BH48RBN	Antenna with 48" pigtail and reverse BNC male
S2403BH36RSM	Antenna with 36" pigtail and reverse SMA male

Additional configurations also available

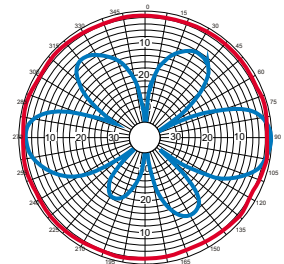

2.4 GHz ■ H-Plane ■ E-Plane

Wide Band 5 GHz 8 dBi Omni Antenna

This high performance outdoor omnidirectional antenna comes with a directly mounted N connector at the base for direct to chassis mounting. The antenna can also be mast mounted using a separate coax jumper (not included).

Specifications:	Part Number S4906BF
Frequency Range (GHz)	4.90-5.85
Gain (dBi)	8 (nominal)
VSWR	<2:1
Polarization	Linear Vertical
Azimuth (3dB beamwidth)	Omnidirectional
Elevation (3dB beamwidth)	16°
Mounting Style	Direct
Power (Watts)	10
Dimension (mm)	12" x 1" (305 x 25)

Antennas in this series

S4906BFNM	Antenna with N male
S4906BFNF	Antenna with N female

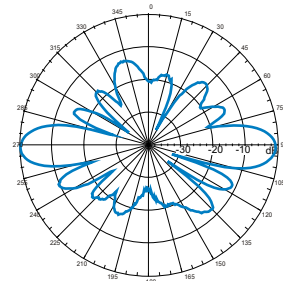

5.45 GHz E-Plane

2.4 & 5.5 GHz 6.5 dBi Dual band Omni Antenna

This omnidirectional indoor/outdoor antenna is dual band covering both 2.4 GHz and wide band 5 GHz. Like all other BPX antennas it includes inverted ceiling, inverted I-beam and standard mast mounting.

Specifications:	Part Number S24513BPX
Frequency Range (GHz)	2.4-2.5 & 5.15-5.875
Gain (dBi)	6.5 (nominal)
VSWR	<2:1
Polarization	Linear vertical
Azimuth (3dB beamwidth)	Omnidirectional
Elevation (3dB beamwidth)	25° (2.4 GHz) / 17° (5.5 GHz)
Mounting Style	Beam / Mast, Ceiling
Power (Watts)	10
Dimensions (mm)	25.5" x 1" (647 x 25)

Antennas in this series

S24513BPX12SMF	Antenna with 12" pigtail and SMA female
S24513BPX36RTN	Antenna with 36" pigtail and reverse TNC male
S24513BPX48RBN	Antenna with 48" pigtail and reverse BNC male
S24513BPX36RSM	Antenna with 36" pigtail and reverse SMA male

Additional configurations also available

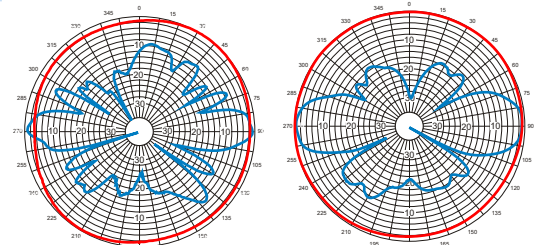

5.5 GHz H-Plane E-Plane 2.45 GHz

Wide Band 5 GHz 10 dBi Omni Antenna

This high gain outdoor omnidirectional antenna comes with a directly mounted N connector at the base for direct to chassis mounting. The antenna can also be mast mounted using a separate coax jumper (not included).

Specifications:	Part Number S4908BF
Frequency Range (GHz)	4.90-5.85
Gain (dBi)	10 (nominal)
VSWR	<2:1
Polarization	Linear Vertical
Azimuth (3dB beamwidth)	Omnidirectional
Elevation (3dB beamwidth)	8°
Mounting Style	Direct
Power (Watts)	10
Dimensions (mm)	19.7" x 1" (508 x 25)

Antennas in this series

S4908BFNM	Antenna with N male
S4908BFNF	Antenna with N female

Additional configurations also available

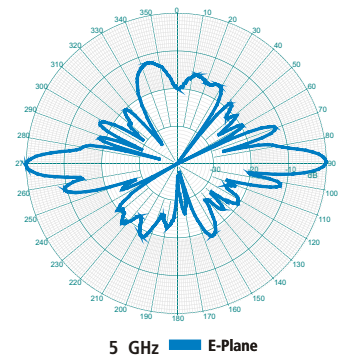

5.15-5.875 GHz 6 dBi Wide Band Omni Antenna

This high performance indoor/outdoor omnidirectional antenna covers the entire 5 GHz band and is rugged enough for outdoor mounting with a clean aesthetic for indoor mounting. Ceiling, I-beam clamp and mast mount hardware are all included in the package.

Specifications:	Part Number S51513WBPX
Frequency Range (GHz)	5.150 - 5.875
Gain (dBi)	6 (nominal)
VSWR	2:1
Polarization	Linear Vertical
Azimuth (3dB beamwidth)	Omnidirectional
Elevation (3dB beamwidth)	17°
Mounting Style	Beam, Mast, Ceiling
Dimensions(mm)	11.5" x 1" (292 x 25)
Power (Watts)	10

Antennas in this series

S5153WBPX12SMF	Antenna with 12" pigtail and type SMA female
S5153WBPX36RTN	Antenna with 36" pigtail and reverse TNC male
S5153WBPX36RSM	Antenna with 36" pigtail and reverse SMA male
S5153WBPX36NM	Antenna with 36" pigtail and type N male

Additional configurations also available

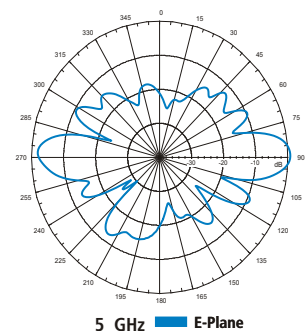

5.150-5.875 GHz 9 dBi Wide-Band Omni Antenna

This high gain indoor/outdoor omnidirectional antenna covers the entire 5 GHz band and is rugged enough for outdoor mounting with a clean aesthetic for indoor mounting. Ceiling, I-beam clamp and mast mount hardware are all included in the package.

Specifications:	Part Number S5158WBPX
Frequency Range (GHz)	5.150-5.875
Gain (dBi)	9 (nominal)
VSWR	2:1
Polarization	Linear Vertical
Azimuth (3dB beamwidth)	Omnidirectional
Elevation (3dB beamwidth)	8°
Mounting Style	Beam, Mast, Ceiling
Dimensions (mm)	19.3" x 1" (490 x 25)
Power (Watts)	10

Antennas in this series

S5158WBPX12SMF	Antenna with 12" pigtail and SMA female
S5158WBPX36RTN	Antenna with 36" pigtail and reverse TNC male
S5158WBPX36RSM	Antenna with 36" pigtail and reverse SMA male

Additional configurations also available

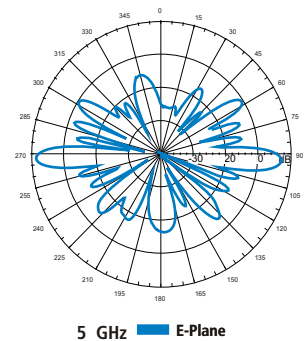

Notes

2.4 GHz 3.5 dBi Omnidirectional Ceiling Mount Antenna

The 4" x 4" x 1" indoor Mini-Squint provides 3.5 dBi gain and antenna can be mounted to ceiling tiles or to I-beams using an added hardware kit.

Specifications:	Part Number SQ2403PG
Frequency Range (GHz)	2.4-2.5
Gain (dBi)	3.5 (nominal)
VSWR	<1.5:1
Polarization	Linear
Azimuth (3dB beamwidth)	Omnidirectional
Elevation (3dB beamwidth)	50° (peak @45°)
Mounting Style	Ceiling mount
Power (Watts)	10
Dimensions (mm)	4" x 4" x 1" (102 x102 x 25)

Antennas in this series

SQ2403PG12NF	Antenna with 12" pigtail and N female
SQ2403PG36RTN	Antenna with 36" pigtail and reverse TNC male
SQ2403PG48RBN	Antenna with 48" pigtail and reverse BNC male
SQ2403PG36RSM	Antenna with 36" pigtail and reverse SMA male

Additional configurations also available

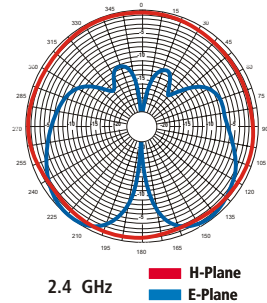

2.3-2.5 GHz 3.5 dBi Omnidirectional Ceiling Panel Antenna

The original indoor ceiling panel design provides the same gain as the "mini" and can be mounted to flat surfaces.

Specifications:	Part Number SQ2303P
Frequency Range (GHz)	2.3 - 2.5
Gain (dBi)	3.5 (nominal)
VSWR	1.5:1
Polarization	Linear
Azimuth (3dB beamwidth)	Omnidirectional
Elevation (3dB beamwidth)	45° (peak @53°)
Mounting Style	Ceiling
Dimensions (mm)	6" x 6"x 1.26" (152 x 152 x 32)
Power (Watts)	10

Antennas in this series

SQ2303P12NF	Antenna with 12" pigtail and N female
SQ2303P36RTN	Antenna with 36" pigtail and reverse TNC male
SQ2303P36RSM	Antenna with 36" pigtail and reverse SMA male
SQ2303P36NM	Antenna with 36" pigtail and N male

Additional configurations also available

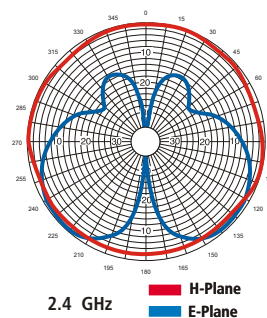

5.150 - 5.875 GHz 3 dBi Omnidirectional Wide-Band Ceiling Mount Squint Antenna

The Laird Technologies low profile indoor ceiling mount omnidirectional panel covers the entire 5 GHz band and is the industry's most popular design. The 36" integrated coax pigtail option allows for making a direct connection to radio.

Specifications:	Part Number SQ5153WP
Frequency Range (GHz)	5.150-5.875
Gain (dBi)	3 (nominal)
VSWR	2:1
Polarization	Linear Vertical
Azimuth (3dB beamwidth)	Omnidirectional
Elevation (3dB beamwidth)	50°
Mounting Style	Ceiling
Dimensions (mm)	2" x 2" x .75" (51 x 51 x 19)
Power (Watts)	5

Antennas in this series

SQ5153WP12SMF	Antenna with 12" pigtail and SMA female
SQ5153WP36RTN	Antenna with 36" pigtail and reverse TNC male
SQ5153WP36SMM	Antenna with 36" pigtail and SMA male
SQ5153WP36RSM	Antenna with 36" pigtail and reverse SMA male

Additional configurations also available

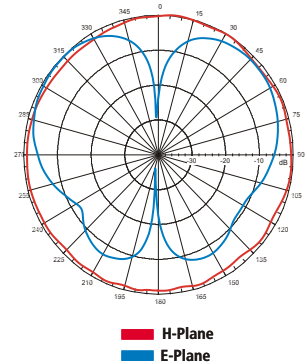

Notes

2.4 GHz 2 dBi Integrated Diversity Omnidirectional Antenna

The industry's first and best indoor 2.4 GHz integrated diversity omnidirectional antenna offers two separate elements and two ports in one package. Antenna comes with drop ceiling support hardware.

Specifications:	Part Number S2402DS
Frequency Range (GHz)	2.4-2.5
Gain (dBi)	2 (nominal)
VSWR	<1.7:1
Polarization	Linear
Azimuth (3dB beamwidth)	Omnidirectional
Elevation (3dB beamwidth)	80°
Mounting Style	Ceiling clip
Power (Watts)	5
Dimensions (mm)	5.25 x 2.75 x .75 (133 x 70 x 19)

Antennas in this series

S2402DS12NF	Antenna with 12" pigtail and N female
S2402DS36RTN	Antenna with 36" pigtail and reverse TNC male
S2402DS36RSM	Antenna with 36" pigtail and reverse SMA male

Additional configurations also available

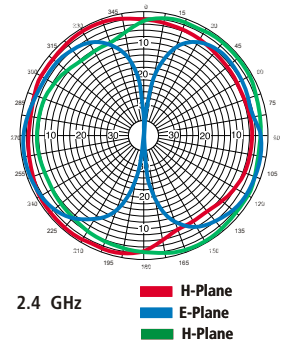
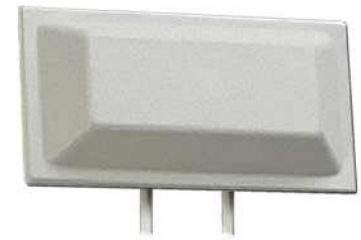

4.90-5.87 GHz 3 dBi Integrated Spatial Diversity Omnidirectional Antenna

This wide band indoor omnidirectional diversity panel antenna system covers the entire 5 GHz band plus the 4.9 GHz band offering two elements and two ports. Implement spatial antenna diversity with one antenna package.

Specifications:	Part Number S4903WDS
Frequency Range (Ghz)	4.90-5.87
Gain (dBi)	3 (nominal)
VSWR	2:1
Polarization	Linear Vertical
Azimuth (3dB beamwidth)	Omnidirectional
Elevation (3dB beamwidth)	50°
Mounting Style	Ceiling Clips
Dimensions (mm)	5.25 x 2.75 x .75 (133 x 70 x 19)
Power (Watts)	2

Antennas in this series

S4903WDS36TNM	Antenna with 36" pigtail and N male
S4903WDS36RTN	Antenna with 36" pigtail and reverse TNC male
S4903WDS36RSM	Antenna with 36" pigtail and reverse SMA male

Additional configurations also available

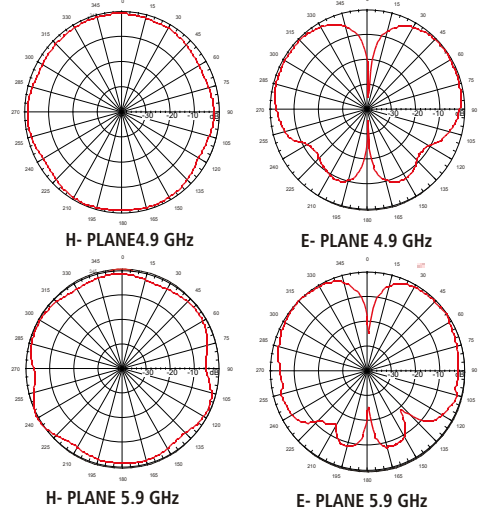

Dual Band Integrated Spatial Diversity Omnidirectional Antenna

The industry standard for indoor dual band multimode integrated omnidirectional diversity offers multiple elements and two ports with both bands available on each port. Antenna mounts to drop ceiling tile supports.

Specifications:	Part Number S24493DS
Frequency Range (GHz)	2.4-2.5 & 4.9-5.9
Gain (dBi)	3 (nominal)
VSWR	<2:1
Polarization	Linear
Azimuth (3dB beamwidth)	Omnidirectional
Elevation (3dB beamwidth)	60°
Mounting Style	Ceiling clip
Power (Watts)	2
Dimensions (mm)	6.1" x 3.6" x .9" (156 x 93 x 23)

Antennas in this series

S24493DS36TNM	Antenna with 36" pigtail and TNC male
S24493DS36RTN	Antenna with 36" pigtail and reverse TNC male
S24493DS36RSM	Antenna with 36" pigtail and reverse SMA male

Additional configurations also available

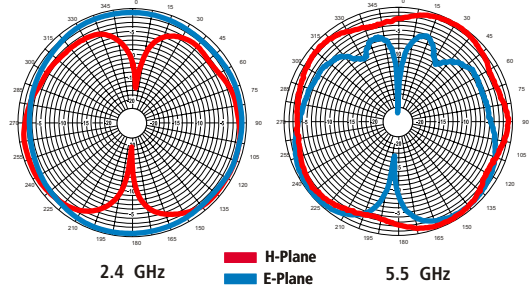
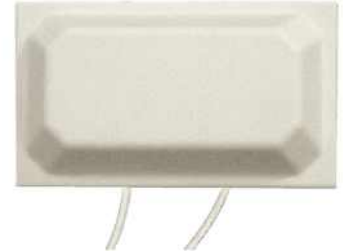

Notes

DIRECTLINK™ 2300-2500 MHz 7.5 dBi Directional Antenna

Indoor/outdoor 2.3-2.5 GHz, 7.5 dBi Wall Mount, 10" coax.

Specifications:	Part Number S2307MP
Frequency Range (MHz)	2300-2500
Gain (dBi)	7.5 (nominal)
VSWR	1.5:1
Polarization	Linear Vertical
Azimuth (3dB beamwidth)	65°
Elevation (3dB beamwidth)	60°
Mounting Style	Wall / Mast
Dimensions (mm)	5.7" x 3.8" x 1.5" x (144 x 97 x 38)
Power (Watts)	75

Antennas in this series

S2307MP36RSM	Antenna with 36" pigtail and reverse SMA male
S2307MP36RTN	Antenna with 36" pigtail and reverse TNC male
S2307MP10SMF	Antenna with 10" pigtail and SMA female

Additional configurations also available

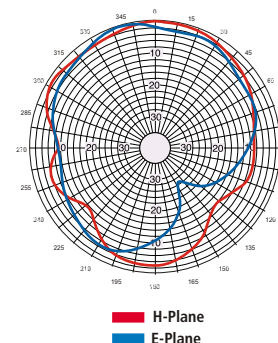

2.4 GHz 6 dBi Directional Panel Antenna

The Indoor panel antenna provides a slim low profile aesthetic that is easy to conceal.

Specifications:	Part Number S2406P
Frequency Range (GHz)	2.4-2.5
Gain (dBi)	6 (nominal)
VSWR	<1.8:1
Polarization	Linear Vertical
Azimuth (3dB beamwidth)	70°
Elevation (3dB beamwidth)	65°
Mounting Style	Wall / Surface
Power (Watts)	10
Dimensions (mm)	5.2" x 3.8" x .5" (132 x 97 x 14)

S2406P12NF	Antenna with 12" pigtail and N female
------------	---------------------------------------

Additional configurations also available

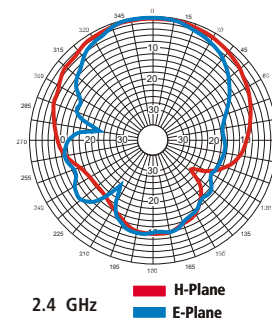

2.5 GHz 8 dBi Directional Panel Antenna

This indoor/outdoor, 2.4 GHz panel antenna provides gain directivity in an attractive easy to install package.

Specifications:	Part Number S2408P12NF
Frequency Range (GHz)	2.4-2.5
Gain (dBi)	8 (nominal)
VSWR	<1.5:1
Polarization	Linear Vertical
Azimuth (3dB beamwidth)	65°
Elevation (3dB beamwidth)	60°
Mounting Style	Surface/ Wall
Power (Watts)	50
Dimensions (mm)	6" x 6" x 1.25"(152 x 152 x 32)

Antennas in this series

S2408P12NF	Antenna with 12" pigtail and N female
------------	---------------------------------------

Additional configurations also available

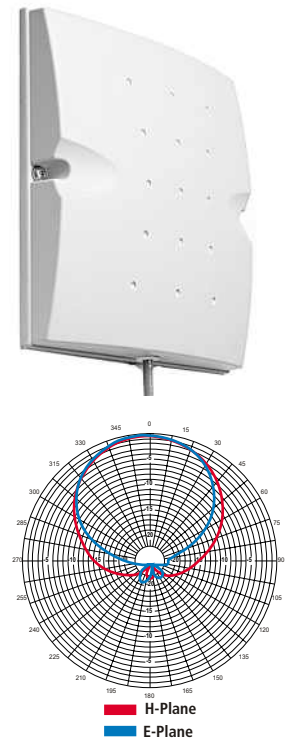

2.4 GHz 12 dBi Directional Panel Antenna

This indoor/outdoor 2.4 GHz, 12 dBi directional antenna features close spaced elements offering high gain in a relatively small package.

Specifications:	Part Number S2401240P
Frequency Range (GHz)	2.4-2.5
Gain (dBi)	12 (nominal)
VSWR	<1.5:1
Polarization	Linear
Azimuth (3dB beamwidth)	40°
Elevation (3dB beamwidth)	35°
Mounting Style	Wall mount
Power (Watts)	25
Dimensions (cm)	6" x 6" x 1.25"(152 x 152 x 32)

Antennas in this series

S2401240P12NF	Antenna with 12" pigtail and N female
S2401240P36RTN	Antenna with 36" pigtail and reverse TNC male
S2401240P12NM	Antenna with 12" pigtail and N male
S2401240P36RSM	Antenna with 36" pigtail and reverse SMA male

Additional configurations also available

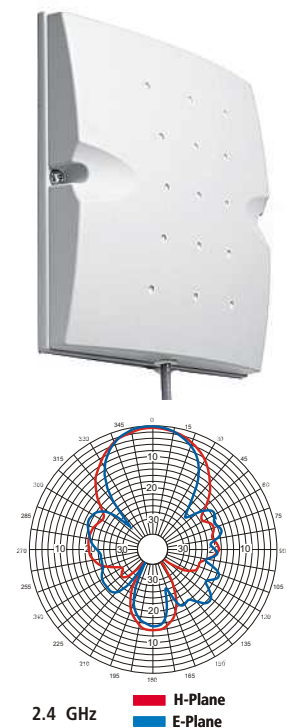

2.5 GHz 15 dBi High Gain Directional Panel Antenna

This outdoor, 15dBi high gain directional antenna can provide point to point service or narrow coverage service and comes in a rugged enclosure with an articulating mount.

Specifications:	Part Number S24015P
Frequency Range (GHz)	2.4-2.5
Gain (dBi)	15 (nominal)
VSWR	<1.5:1
Polarization	Linear Vertical
Azimuth (3dB beamwidth)	31°
Elevation (3dB beamwidth)	29°
Mounting Style	Wall / Mast
Power (Watts)	50
Dimensions (mm)	10" x 10" x 1.5" (254 x 254 x 38)

S24015P12NF Antenna with 12" pigtail and N female

Additional configurations also available

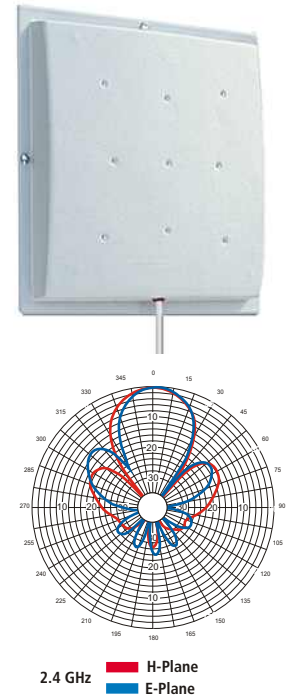

DIRECTLINK™ 5150-5350 MHz Antenna

This indoor/outdoor 5.15-5.35 ,12 dBi, Wall Mount can be wall or mast mounted.

Specifications:	Part Number S51512MP
Frequency Range (MHz)	5150-5350
Gain (dBi)	12 (nominal)
VSWR	1.5:1
Polarization	Linear Vertical
Azimuth (3dB beamwidth)	58°
Elevation (3dB beamwidth)	30°
Mounting Style	Wall / Mast
Dimensions (mm)	5.7" x 3.8" x 1.5"(144 x 97 x 38)
Power (Watts)	75

Antennas in this series

S51512MP10SMF	Antenna with 10" pigtail and SMA female
S51512MP36RTN	Antenna with 36" pigtail and reverse TNC male
S51512MP36RSM	Antenna with 36" pigtail and reverse SMA male

Additional configurations also available

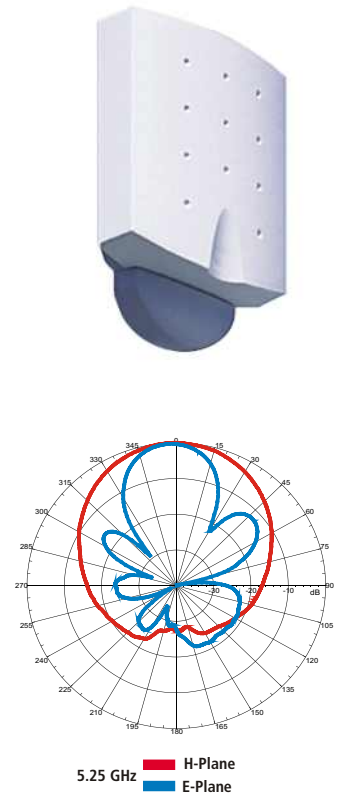

5.15-5.875 GHz 14 dBi Directional Wide-Band Antenna

This indoor/outdoor high performance panel covers the entire 5 GHz band and includes an articulating mount kit that will accommodate wall and mast mounts.



Specifications:	Part Number S51514WP
Frequency Range (GHz)	5.150 - 5.875
Gain (dBi)	14 (nominal)
VSWR	2:1
Polarization	Linear Vertical
Azimuth (3dB beamwidth)	31°
Elevation (3dB beamwidth)	27°
Mounting Style	Wall / Mast
Dimensions (mm)	4" x 4" x 1.4"(102 x 102 x 35)
Power (Watts)	10

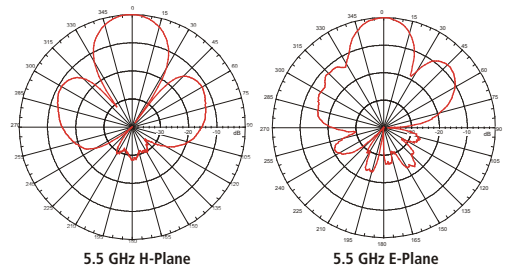

Antennas in this series

S51514WP36NM	Antenna with 36" pigtail and N male
S51514WP36RTN	Antenna with 36" pigtail and reverse TNC male
S51514WP36RSM	Antenna with 36" pigtail and reverse SMA male
S51514WP12SMF	Antenna with 12" pigtail and SMA female

Additional configurations also available

5.47 - 5.85 GHz 17 dBi Wide band Directional Panel Antenna

This outdoor 5.47-5.9 GHz rugged panel antenna is perfect for point to point applications or client antennas.



Specifications:	Part Number S54717P
Frequency Range (GHz)	5.47-5.85
Gain (dBi)	17 (nominal)
VSWR	1.5:1
Polarization	Linear Vertical
Azimuth (3dB beamwidth)	17°
Elevation (3dB beamwidth)	17°
Mounting Style	Wall / Mast
Dimensions (mm)	6.7" x 6.7" x 1.9"(171 x 171 x 48)
Power (Watts)	10

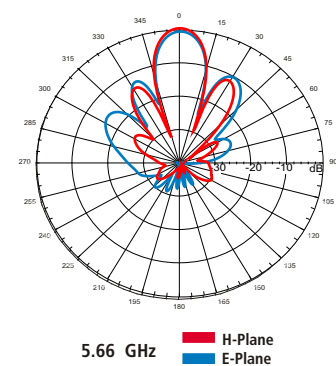

Antennas in this series

S54717P12NM	Antenna with 12" pigtail and N male
S54717P36NM	Antenna with 36" pigtail and N male

Additional configurations also available

2.4 & 5.9 GHz 7 dBi Dual Band Panel Antenna

The is an indoor/outdoor high performance dual band multimode directional panel antenna. The antenna comes standard with a wall/mast articulating mount.

Specifications:	Part Number S24497P
Frequency Range (GHz)	2.4-2.5 & 4.9-5.9
Gain (dBi)	7 (nominal)
VSWR	<2.0:1
Polarization	Linear
Azimuth (3dB beamwidth)	68° (2.5GHz) / 52°(5.0 GHz)
Elevation (3dB beamwidth)	66° (2.5 GHz) /60° (5.0 GHz)
Mounting Style	Wall
Power (Watts)	10
Dimensions (mm)	4" x 4" x 1.8"(104 x 104 x 45)

Antennas in this series

S24497P36TNM	Antenna with 36" pigtail and TNC male
S24497P36RTN	Antenna with 36" pigtail and reverse TNC male
S24497P36RSM	Antenna with 36" pigtail and reverse SMA male

Additional configurations also available

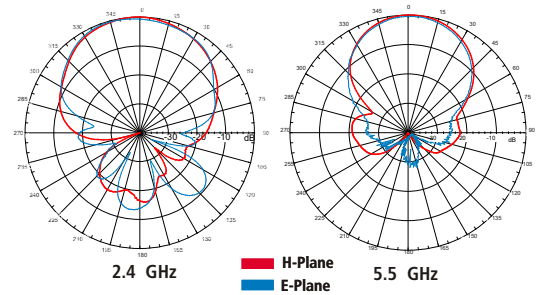

Notes

2.4 GHz 6.5 dBi Spatial Diversity Directional Antenna

The industries first and best indoor 2.4 GHz integrated diversity directional antenna offers two separate elements and two ports in one package. Antenna comes with wall mount hardware. Articulating mount available.

Specifications:	Part Number S2406DSP
Frequency Range (GHz)	2.4-2.5
Gain (dBi)	6.5 (nominal)
VSWR	<1.7:1
Polarization	Linear
Azimuth (3dB beamwidth)	80°
Elevation (3dB beamwidth)	55°
Mounting Style	Wall/surface
Power (Watts)	10
Dimensions (mm)	6.5" x 4.7" x .8" (165 x 12 x 2)

Antennas in this series

S2406DSP12NF	Antenna with 12" pigtail and N female
S24497P36RTN	Antenna with 36" pigtail and reverse TNC male
S24497P36RSM	Antenna with 36" pigtail and reverse SMA male

Additional configurations also available

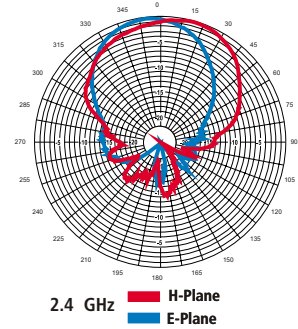
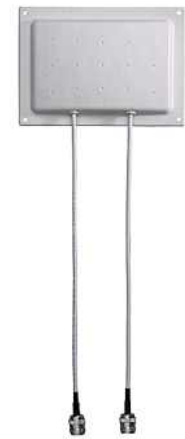

Notes

2.4 GHz 13.9 dBi Directional Antenna

Laird's Technologies indoor/outdoor high gain 2.4 GHz yagi antenna is completely enclosed and terminates in a short flexible pigtail to accommodate transitions to heavier coax jumpers. Antenna comes complete with mast mounting hardware and an optional articulating mount is available.

Specifications:	Part Number PC2415N
Frequency Range (GHz)	2.4-2.5
Gain (dBi)	13.9 (nominal)
VSWR	<1.5:1
Polarization	Linear
Azimuth (3dB beamwidth)	34°
Elevation (3dB beamwidth)	30°
Mounting Style	Wall / Mast
Power (Watts)	50
Dimensions (mm)	25" x 3.7" x 1.7"(633 x 95 x 38)

Antennas in this series

PC2415N	Antenna with 12" pigtail and N female
PC2415NA	Antenna with 12" pigtail, N female and articulating mount

Additional configurations also available

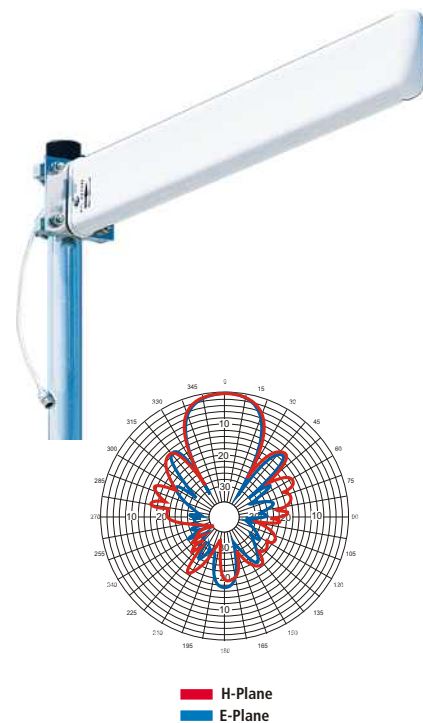

2.5 GHz Directional Ceiling Mount 8 dBi Array

This indoor 8 dBi yagi antenna is designed to be mounted to ceiling tiles and can be used to direct signal down long narrow coverage areas like airport concourses.

Specifications:	Part Number S2408MD
Frequency Range (GHz)	2.4-2.5
Gain (dBi)	8 (nominal)
VSWR	<1.5:1
Polarization	Linear Vertical
Azimuth (3dB beamwidth)	66°
Elevation (3dB beamwidth)	56°
Mounting Style	Ceiling / Surface
Power (Watts)	50
Dimensions (mm)	7.2" x 3.7" x 2"(184 x 95 x 51)

Antennas in this series

S2408MD12NF	Antenna with 12" pigtail and N female
-------------	---------------------------------------

Additional configurations also available

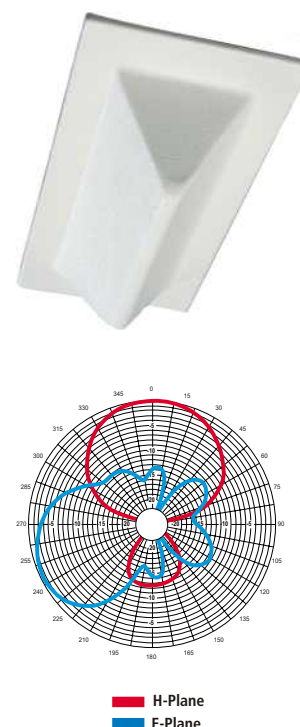

2.4 GHz 5 dBi Wide Angle Panel Antenna

DA option with articulating mount included.

Specifications:	Part Number SR2405135D
Frequency Range (GHz)	2.4-2.5
Gain (dBi)	5 (nominal)
VSWR	<1.5:1
Polarization	Linear
Azimuth (3dB beamwidth)	135°
Elevation (3dB beamwidth)	55°
Mounting Style	Wall
Power (Watts)	25
Dimensions (mm)	6" x 3" x 2"(152 x 76 x 50)

Antennas in this series

SR2405135DA12NF	Antenna with 12" pigtail and type N female
SR2405135DA36RTN	Antenna with 36" pigtail and reverse TNC male
SR2405135DA72RBN	Antenna with 72" pigtail and reverse BNC male
SR2405135DA72NM	Antenna with 72" pigtail and N male

Additional configurations also available

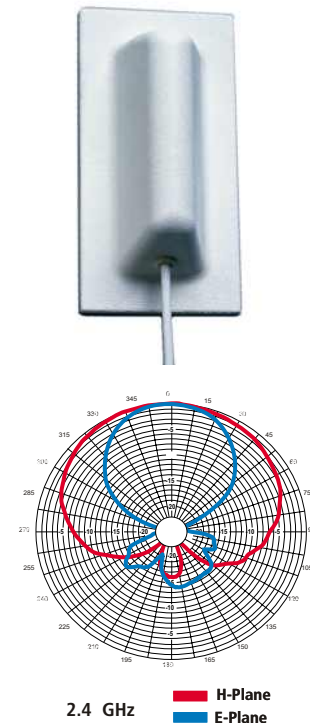

2.4 GHz 7dBi Wide Angle Panel Antenna

This indoor/outdoor 2.4 GHz 90 degree sector antenna offers wide angle coverage from a wall mount location.

Specifications:	Part Number S240790P
Frequency Range (GHz)	2.4-2.5
Gain (dBi)	7 (nominal)
VSWR	<1.5:1
Polarization	Linear
Azimuth (3dB beamwidth)	90°
Elevation (3dB beamwidth)	60°
Mounting Style	Wall
Power (Watts)	25
Dimensions (mm)	6" x 4.6" x 1"(155 x 118 x 25)

Antennas in this series

S240790P12NF	Antenna with 12" pigtail and type N female
S240790P36RTN	Antenna with 36" pigtail and reverse TNC male
S240790P36RBN	Antenna with 36" pigtail and reverse BNC male
S240790P36RSM	Antenna with 36" pigtail and reverse SMA male

Additional configurations also available

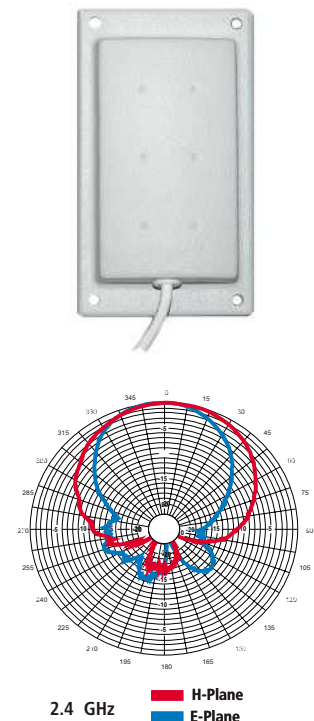

2.4 GHz 11 dBi Wide Angle Directional Sector Antenna

This indoor/outdoor 2.4 GHz 120 degree sector antenna can either be used as an outdoor mast mount sector antenna or a wall mount wide coverage area directional antenna from a wall mount location.

Specifications:	Part Number SR24011120D
Frequency Range (GHz)	2.4-2.5
Gain (dBi)	11 (nominal)
VSWR	<1.5:1
Polarization	Linear
Azimuth (3dB beamwidth)	120°
Elevation (3dB beamwidth)	13°
Mounting Style	Wall/mast mount
Power (Watts)	25
Dimensions (mm)	3" x 23" x 2" (76 x 584 x 51)

Antennas in this series

SR24011120D12NF	Antenna with 12" pigtail and N female
SR24011120D36NM	Antenna with 36" pigtail and N male

Additional configurations also available

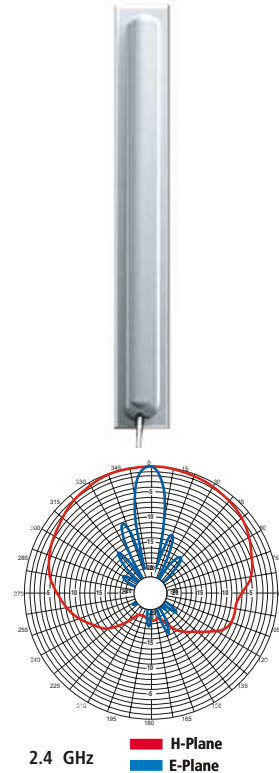

5.15-5.35 GHz 120° 11 dBi Sector Antenna

This outdoor high gain sector antenna covers the entire 5 GHz band and is available with tilt hardware for sector coverage from a mast location (WDA option). The WD option is the antenna only without tilt hardware providing a flush wall mounting option for wide H-plane coverage applications.

Specifications:	Part Number SR5120WD
Frequency Range (GHz)	5.15-5.875
Gain (dBi)	11 (nominal)
VSWR	1.5:1
Polarization	Linear Vertical
Azimuth (3dB beamwidth)	120°
Elevation (3dB beamwidth)	15°
Mounting Style	Wall / Mast
Dimensions (mm)	9.5" x 1.0" x 2.4" (242 x 26 x 61)
Power (Watts)	10

Antennas in this series

SR5120WDA12NF	Antenna with 12" pigtail and N female
SR5120WD12NF	Antenna with 12" pigtail and reverse N female

Additional configurations also available

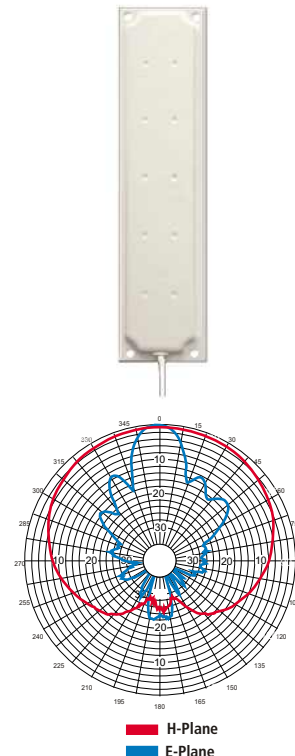

ETSI CS1 VPOL 5 GHz 16.5 dBi Sector Antenna

This outdoor high gain wide band 4.9-5.87GHz 90 Deg. Sector comes with tilt mount hardware and a directly mounted (no pigtail option) N-Female connector.

Specifications:	Part Number S4901790PNF
Frequency Range (GHz)	4.9-5.8
Gain (dBi)	16.5 (nominal)
VSWR	2.0:1
Polarization	Linear Vertical
Azimuth (3dB beamwidth)	90°
Elevation (3dB beamwidth)	5.5°
Null Fill	Down to -25°
Sidelobe Suppression	>20dB
Dimensions (mm)	25" x 2" x 3" (635 x 51 x 76)

S4901790PNF Antenna with N female

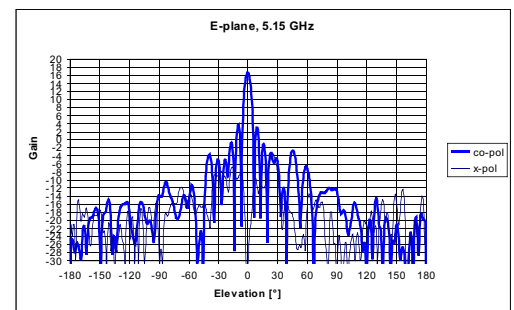

2.4 & 5.0 GHz 5 dBi Dual band 120° Sector Antenna

Laird's Technologies indoor dual directional ceiling mount panel antenna is perfect for hallways with multiple rooms off the hallway. This antenna is well suited to hotel applications for example.

Specifications:	Part Number SR249120D
Frequency Range (GHz)	2.4-2.5 / 4.9-5.9
Gain (dBi)	5 (nominal)
VSWR	<1.5:1
Polarization	Linear vertical
Azimuth (3dB beamwidth)	120°
Elevation (3dB beamwidth)	65°
Mounting Style	Wall/mast mount
Power (Watts)	5
Dimensions (mm)	5.1" x 2.1" x 1.4" (131 x 55 x 35)

Antennas in this series

SR249120D12NF	Antenna with 12" pigtail and N female
SR249120D36RTN	Antenna with 36" pigtail and reverse TNC male
SR249120D36NM	Antenna with 36" pigtail and N male

Additional configurations also available

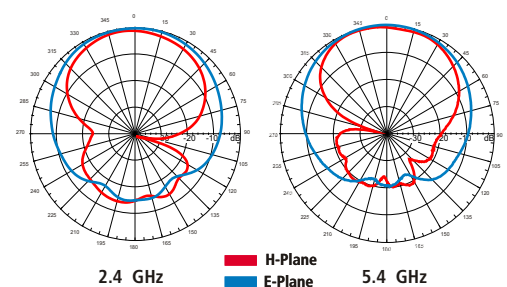

2.4 GHz 4dBi Bi-directional Ceiling Mount Antenna

Laird Technologies indoor dual directional ceiling mount panel antenna is perfect for hallways with multiple rooms off the hallway. This antenna is well suited to hotel applications, for example.

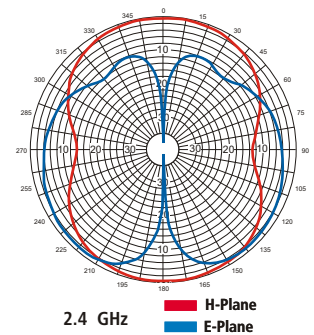

Specifications: Part Number SQ2405DD

Frequency Range (GHz)	2.4-2.5
Gain (dBi)	4 (nominal)
VSWR	<1.5:1
Polarization	Linear vertical
Azimuth (3dB beamwidth)	87°
Elevation (3dB beamwidth)	58°
Mounting Style	Ceiling
Power (Watts)	10
Dimensions (mm)	6" x 6" x 1.25" (155 x 155 x 35)

Antennas in this series

SQ2405DD12NF	Antenna with 12" pigtail and N female
SQ2405DD36RTN	Antenna with 36" pigtail and reverse TNC male
SQ2405DD36RSM	Antenna with 36" pigtail and reverse SMA male

Additional configurations also available

Notes

2.4 GHz 2.5 dBi Omnidirectional Ceiling Mount Antenna

This versatile indoor antenna can be oriented in any axis to provide service. Spring clip mounting is standard but the antenna can be modified for hook and loop as well.

Specifications:	Part Number SL2402P
Frequency Range (GHz)	2.4-2.5
Gain (dBi)	2.5 (nominal)
VSWR	<1.7:1
Polarization	Linear
Azimuth (3dB beamwidth)	Omnidirectional
Elevation (3dB beamwidth)	160°
Mounting Style	Ceiling clip
Power (Watts)	10
Dimensions (mm)	2" x 2" x .71" (51 x 51 x 18)

Antennas in this series

SL2402PX12MMX	Antenna with dual 12" pigtail and MMX male
SL2402PX36RTN	Antenna with 36" pigtail and reverse TNC male

Additional configurations also available

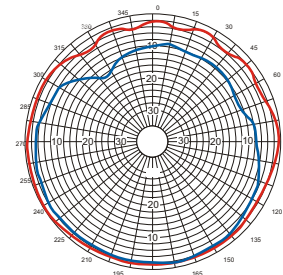

2.4 GHz ■ H-Plane ■ E-Plane

2.4 & 5.0 GHz Dual band Omni Squint Antenna

This antenna is an excellent choice for multimode 802.11b/a/g applications and is often used for health care monitors, portable printers and in any limited range multimode requirement where size is an issue.

Specifications:	Part Number SL24513P
Frequency Range (GHz)	2.4-2.5 / 5.15-5.35
Gain (dBi)	3 (nominal)
VSWR	<2.0:1
Polarization	Linear
Azimuth (3dB beamwidth)	Omnidirectional
Elevation (3dB beamwidth)	120°/80°
Mounting Style	Ceiling grid
Power (Watts)	10
Dimensions (mm)	2" x 2" x .71" (51 x 51 x 18)

Antennas in this series

SL24513P12MMX	Antenna with dual 12" pigtail and MMX
SL24513P12SMF	Antenna with 36" pigtail and SMA female

Additional configurations also available

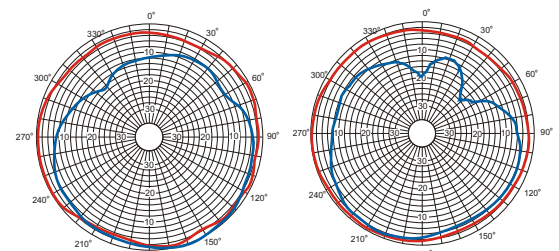

2.45 GHz ■ H-Plane ■ E-Plane 5.25 GHz

2.4 GHz 3dBi Mobile Antenna

These low profile Phantom® mobile antennas are a perfect choice for all sorts of applications, from low profile ceiling mounts to WLAN vehicular mounts.

Specifications:	Part Number TRA24003
Frequency Range (GHz)	2.4-2.5
Gain (dBi)	3 (nominal)
VSWR	<2.0:1
Polarization	Vertical & Horizontal
Azimuth (3dB beamwidth)	Omnidirectional
Elevation (3dB beamwidth)	130°
Mounting Style	Hole, magnetic and ceiling mount
Power (Watts)	150 (max)
Dimensions (mm)	2.3" x 1.4" (58 x 35)

Antennas in this series

TRA24003	White radome, 2.4 -2.5 GHz, 3 dB with .75" NMO mount
TRA58003	White radome, 4.9 -6.0 GHz, 3 dB with .75" NMO mount

Additional configurations also available

5 GHz 5dBi Omni In-Building Antenna

Small in aspect, this Laird Technology 5 GHz access point antenna, can be mounted in any orientation to provide coverage.

Specifications:	Part Number IO5250
Frequency Range (GHz)	5.15-5.35
Gain (dBi)	5 (nominal)
VSWR	<2.0:1
Polarization	Linear
Azimuth (3dB beamwidth)	Omnidirectional
Impedance	50 ohms
Mounting Style	Ceiling/surface
Power (Watts)	50
Dimensions (mm)	4" x 4.1" x 1.6" (102 x 104 x 42)

Antennas in this series

IO5250-RT36	Antenna with 36" pigtail reverse TMC male
-------------	---

Additional configurations also available



**Patented
Field Diversity™**

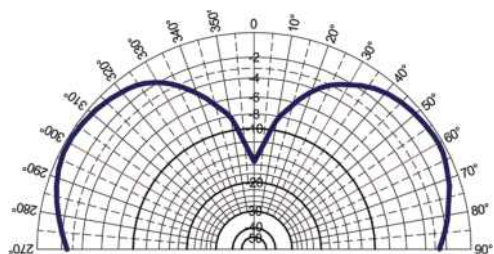

2.4 GHz ■ E-Plane

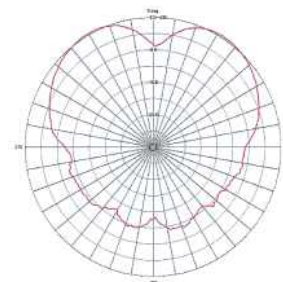

5 GHz ■ E-Plane

2.4 GHz 3 dBi Mobile Dipole Antenna

These antennas are available with a number of connector options including reverse polarity TNC and reverse polarity SMA in the 2.4 GHz band and also in the 5 GHz band.

Specifications:	Part Number WXE2400
Frequency Range (GHz)	2.4-2.5
Gain (dBi)	3 (nominal)
VSWR	<1.5:1
Polarization	Vertical
Azimuth (3dB beamwidth)	Omnidirectional
Impedance	50 ohms
Mounting Style	Direct
Power (Watts)	50(max)
Length (mm)	5.5"(139)

Antennas in this series

WXE2400-SM	Flexible Antenna with flush SMA male
WXE2400-SMLH	Flexible Antenna with flush SMLH male

Additional configurations also available



2.4 and 5 GHz Omni In-Building Antenna

These adjustable right angle antennas cover 2.4-2.5 and 4.9-6.0 GHz and are available with a number of connector options including reverse polarity TNC and reverse polarity SMA.

Specifications:	Part Number WTS2450
Frequency Range (GHz)	2.4-2.4 & 4.9-5.8
Gain (dBi)	2.1 / 2.6
VSWR	<2.0:1
Polarization	Linear
Azimuth (3dB beamwidth)	Omnidirectional
Impedance	50 ohms
Mounting Style	RPSMA
Dimensions (mm)	3.7" x .36"(95.9 x 9.3)

Antennas in this series

WTS2450-RPSMA	Right angle with reverse SMA male
---------------	-----------------------------------

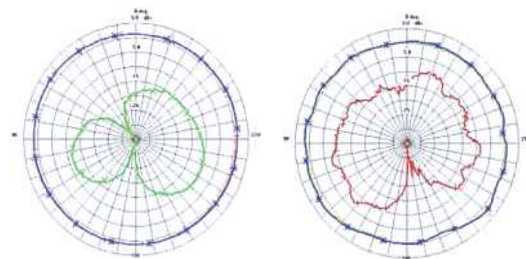

2.4 GHz

5.8 GHz

2.4 GHz 3 dBi In-Building Omni Antenna

The smallest of the Laird Technologies 2.4 GHz access point antennas, the Microsphere™ can be mounted in any orientation to provide coverage.

Specifications:	Part Number IF2450-SFOO
Frequency Range (GHz)	2.4-2.5
Gain (dBi)	3 (nominal)
VSWR	<1.5:1
Polarization	Linear
Azimuth (3dB beamwidth)	Omnidirectional
Impedance	50 ohms
Mounting Style	Ceiling/surface
Power (Watts)	50(max)
Dimensions (mm)	1.8" x 1.2" x .1"(46 x 3 x 2.5)

Antennas in this series

IF2450-SFOO	Panel antenna with SMA female
-------------	-------------------------------

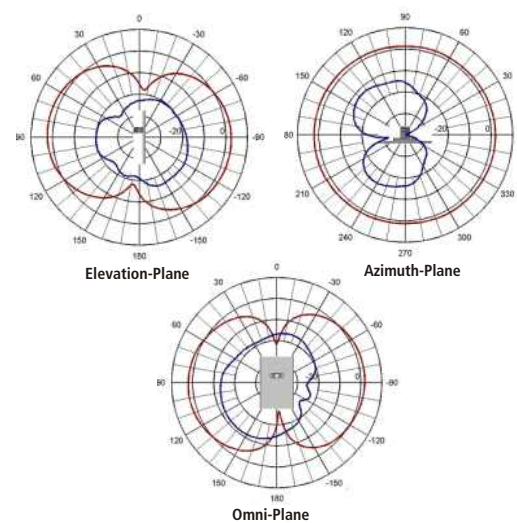

Notes

Accessories

Laird Technologies accessories are the perfect complement to our antenna systems. Cable assemblies, surge suppressors, lightning arrestors, POE inserters and splitters, wall and rooftop antenna mounts, connector adapters and die cast aluminum enclosures are available.



Patented Field Replaceable Ethernet Connector System

- Part number RJ45-ECS
- IP67 rated

Power over Ethernet (POE) Inseters and Splitters

- 16W to 50W models, many different voltages available
- Built in surge suppression
- 802.3af compatible



Lightning Arrestors

- Gas discharge and 1/4 wave DC ground
- Multiple strike capability
- Wide band models DC-6000MHz
- Insertion loss 0.3dB max



Ethernet Surge Suppressors

- Compatible with POE equipment
- Protects data and DC power lines

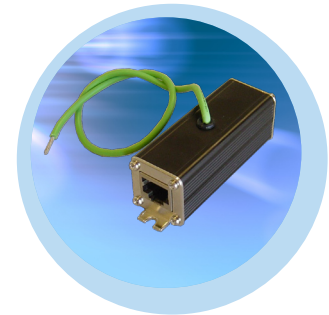

Cable Assemblies

- Standard and custom assemblies
- Low insertion loss
- Qualified to 6GHz



Wall and Roof Antenna Mounts

- Perfect for CPE mounting
- Fixed wall mount
- Adjustable angle roof/wall mount

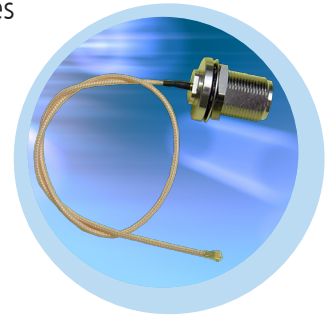

Die Cast Enclosures

- Perfect for housing outdoor electronics
- Multiple engineered knockouts for flexibility
- NEMA 6 rated

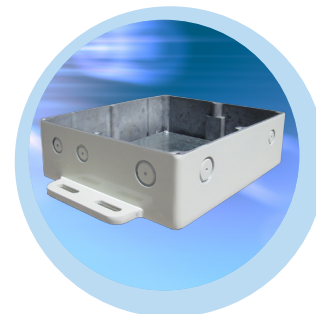

Notes

NORTH AMERICA

Our USA toll-free telephone number
+1.866.881.9910

Bluffdale, USA

14557 South 790 West Unit B
Bluffdale, UT 84065
Phone +1.801.572.3024
Fax +1.801.572.3025

Chicago, USA

1751 Wilkening Court
Schaumburg, IL 60173
Phone +1.847.839.6000
Fax +1.847.839.6036

Manchester, USA

48 Perimeter Road
Manchester, NH 03103
Phone +1.603.627.7877
Fax +1.603.627.1764

ASIA

Shanghai, China

Building 1, Number 58
Hua Ning Road, Lane 4018
Shanghai, P.R. China 201108
Phone +86.21.6442.8018
Fax +86.21.6489.6055

Seoul, Korea

A-4th Floor, Woorim Lion's Valley
371-28, Gasan-Dong, Gumcheon-Gu,
Seoul 153-786 Korea
Phone: +82.2.830.2095
Fax: +82.2.830.1945

Singapore

750E Chai Chee Road #03.07/08
Technopark@Chai Chee
Singapore 469005
Phone +65.624.38022
Fax +65.624.38021

Taiwan

3F, No 92, Shi.Weï Street
San Chung City, Taipei Hsien
Taiwan, ZIP 241
Phone +866.2.2286.2828 ext 37
Fax +886.2.2286.2323

EUROPE

Germany

AuBere OberaustraBe 22
83026
Rosenheim, Germany
Phone +49.8031.24600
Fax +49.8031.246050

Sweden

Laird Technologies AB
P.O.Box 500, Näs vägen 15
S-184 25 Åkersberga
Sweden
Phone: +46.8555.72200
Fax: +46.8555.72210

NOTICE: Although the information and recommendations set forth herein (hereinafter "information") are presented in good faith and believed to be correct as of the date hereof, Laird Technologies makes no representation or warranties as to the completeness or accuracy thereof. Information is supplied upon the condition that the persons receiving same will make their own determination as to its suitability for their purposes prior to use. In no event will Laird Technologies be responsible for damages of any nature whatsoever resulting from the use or reliance upon information or the product to which information refers. Nothing contained herein is to be construed as a recommendation to use any product, process, equipment or formulation in conflict with any patent, and Laird Technologies makes no representation or warranty, expressed or implied, that the use thereof will not infringe any patent. The data set forth in all tables, charts, graphs and figures herein are based on samples tested and are not guaranteed for all samples or applications. Such data are intended as guides and do not reflect product specifications for any particular product. NO REPRESENTATION OR WARRANTIES, EITHER EXPRESSED OR IMPLIED, OR MERCHANTABILITY, FITNESS FOR A PARTICULAR PURPOSE OR OF ANY OTHER NATURE ARE MADE HEREUNDER WITH RESPECT TO INFORMATION OR THE PRODUCT TO WHICH INFORMATION REFERS.

global solutions :
local support™

global solutions : **local support** [™]

Laird Technologies is the world's leader in the design and supply of customized performance-critical products for wireless and other advanced electronic applications.

Laird Technologies partners with its customers to help find solutions for applications in various industries such as aerospace, automotive electronics, computer, consumer electronics, data communications, medical equipment, military, network equipment and telecommunications.

